

A thick, horizontal blue brushstroke graphic that spans across the width of the page, positioned below the number '1' and above the title.

Getting Started

Thank you for purchasing the MS-6747 v1.X M-ATX mainboard. The MS-6747 is based on **Intel® 865PE & Intel® ICH5/ICH5R** chipsets for optimal system efficiency. Designed to fit the advanced **Intel® Pentium 4** processor in the 478-pin package, MS-6747 delivers a high performance and professional desktop platform solution.

Mainboard Specifications

CPU

- Supports Socket 478 for Intel® Pentium 4 (Socket 478) processor
- Supports Socket 478 for Intel® Northwood/Prescott processor
- Supports up to 3.2 GHz or higher speed P4 processor

Chipsets

- Intel® Springdale-865PE chipset
 - Supports AGP 8x/4x at 0.8V (AGP 3.0) or 4x at 1.5V (not supports 3.3V)
 - Supports 133/166/200MHz memory FSB
 - Supports 400/533/800MHz Intel NetBurst micro-architecture bus.
- Intel® ICH5/ICH5R chipset (421 mBGA)
 - AC'97 2.3 interface
 - 8 USB 2.0/1.1 ports
 - 2 channel Ultra ATA/100 Bus Master IDE controller
 - SMBus 2.0 support
 - 2 serial ATA Host Controllers (Optional)
 - RAID 0 supported by ICH5R (Optional)

Main Memory

- Support eight memory banks using four 184-pin unbuffered DIMM
- Max memory size is 4GB w/o ECC for (1GB/slot)
- Support 2.6V DDR DIMM

Slots

- Three 32-bit Master PCI Bus slot
- One mini PCI slot (Optional)
- One AGP(Accelerated Graphic Port) slot

On-Board IDE

- An IDE controller on the ICH5 chipset provides IDE HDD/CD-ROM with PIO, Bus Master and Ultra DMA66/100/133 operation modes.
- Can connect up to four IDE devices.

On-Board Peripherals

- On-Board Peripherals include:
 - 1 floppy port supports 2 FDD with 360K, 720K, 1.2M, 1.44M and 2.88 Mbytes.
 - 1 serial port, 2 serial ports

- 1 parallel port supports SPP/EPP/ECP mode
- 7 USB 2.0 / 1.1 ports (Rear*4 / Front*3)
- 1 Front USB 2.0 / 1.1 port for Card Reader
- 1 Line-In / 3 Line-Out / 1 Mic
- 1 RJ45 connector
- 2 1394 ports (4 Pins*1 / 6 Pins*1)
- 1 SPDIF OUT/IN

Audio

- S/W C-Media 9739A 5.1 channel with SPDIF in/out.

LAN(optional)

- VIA® VT6105 LAN controller

BIOS

- The mainboard BIOS provides “Plug & Play” BIOS which detects the peripheral devices and expansion cards of the board automatically.
- The mainboard provides a Desktop Management Interface (DMI) function which records your mainboard specifications.

Dimension

- M-ATX Form Factor: 24.38 cm (L) x 24.38 cm (W)

Mounting

- 6 mounting holes

Others

- Support STR/STD
- PC 2001 compliant

Mainboard Layout

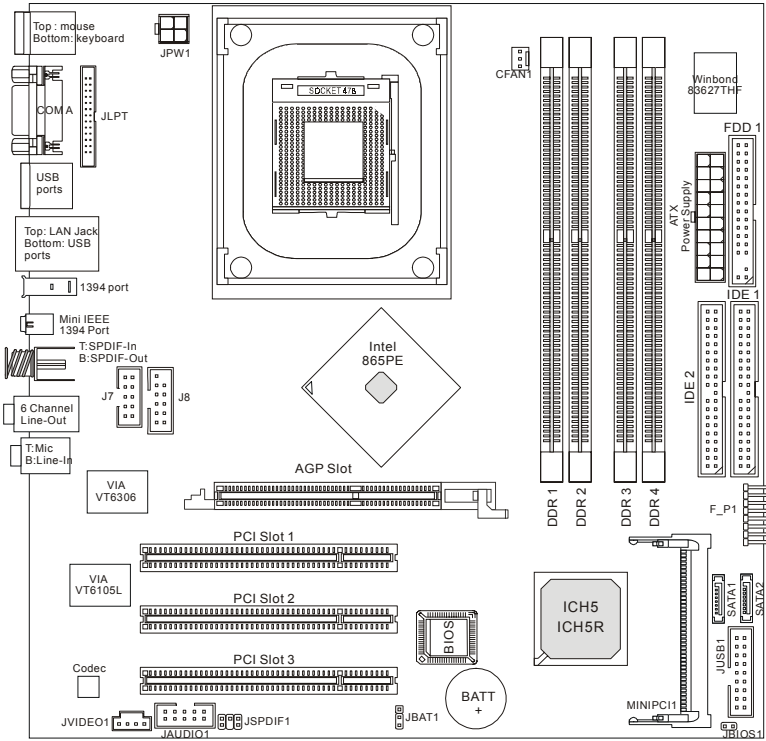

MS-6747 v1.X M-ATX Mainboard

2



Hardware Setup

This chapter tells you how to install the CPU, memory modules, and expansion cards, as well as how to setup the jumpers on the mainboard. Also, it provides the instructions on connecting the peripheral devices, such as the mouse, keyboard, etc.

While doing the installation, be careful in holding the components and follow the installation procedures.

Quick Components Guide

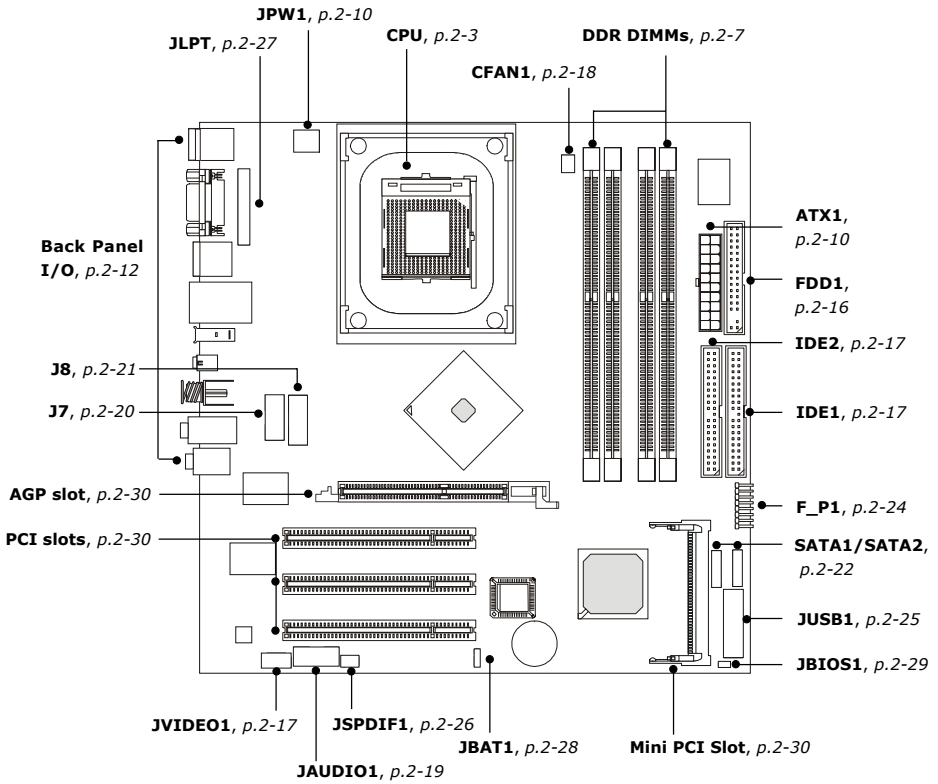

Central Processing Unit: CPU

The mainboard supports Intel® Pentium® 4/Celeron Northwood/Prescott processor in the 478 pin package. The mainboard uses a CPU socket called PGA478 for easy CPU installation. When you are installing the CPU, **make sure the CPU has a heat sink and a cooling fan attached on the top to prevent overheating.** If you do not find the heat sink and cooling fan, contact your dealer to purchase and install them before turning on the computer.

CPU Core Speed Derivation Procedure

CPU Clock multiplied by **Core/Bus ratio** equals the CPU core speed.

For example:

If	CPU Clock	=	100MHz
	Core/Bus ratio	=	14
then	CPU core speed	=	Host Clock x Core/Bus ratio
		=	100MHz x 14
		=	1.4 GHz

CPU Installation Procedures for Socket 478

1. Please turn off the power and unplug the power cord before installing the CPU.
2. Pull the lever sideways away from the socket. Make sure to raise the lever up to a 90-degree angle.
3. Look for the cut edge. The cut edge should point towards the lever pivot. The CPU can only fit in the correct orientation.
4. If the CPU is correctly installed, the pins should be completely embedded into the socket and can not be seen. Please note that any violation of the correct installation procedures may cause permanent damages to your mainboard.
5. Press the CPU down firmly into the socket and close the lever. As the CPU is likely to move while the lever is being closed, always close the lever with your fingers pressing tightly on top of the CPU to make sure the CPU is properly and completely embedded into the socket.

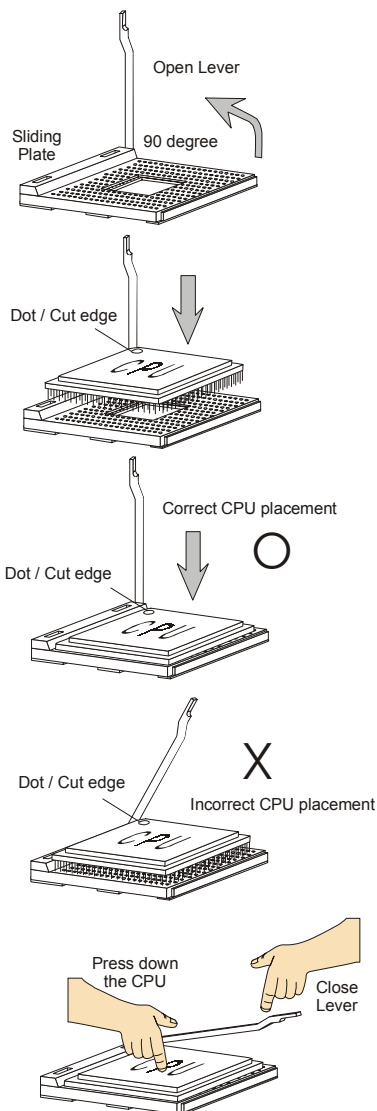

Installing the CPU Fan

As processor technology pushes to faster speeds and higher performance, thermal management becomes increasingly important. To dissipate heat, you need to attach the CPU cooling fan and heatsink on top of the CPU. Follow the instructions below to install the Heatsink/Fan:

1. Locate the CPU and its retention mechanism on the motherboard.
2. Position the heatsink onto the retention mechanism.

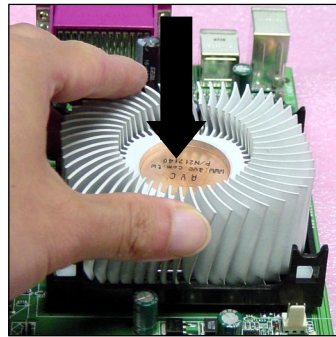
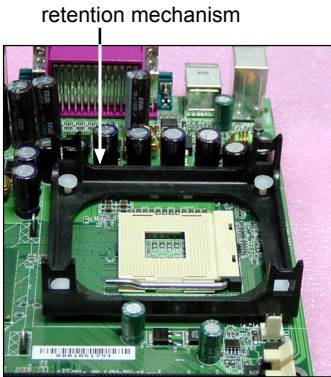

3. Mount the fan on top of the heatsink. Press down the fan until its four clips get wedged in the holes of the retention mechanism.
4. Press the two levers down to fasten the fan. Each lever can be pressed down in only ONE direction.

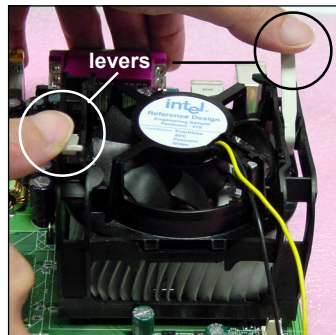
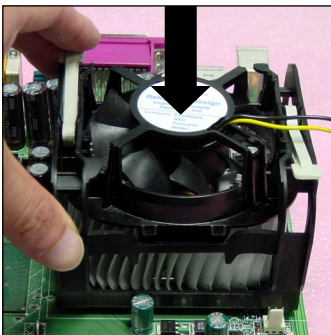

5. Connect the fan power cable from the mounted fan to the 3-pin fan power connector on the board.

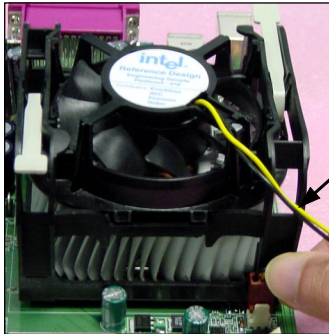

fan power cable



MSI Reminds You...

Overheating

Overheating will seriously damage the CPU and system, always make sure the cooling fan can work properly to protect the CPU from overheating.

Replacing the CPU

While replacing the CPU, always turn off the ATX power supply or unplug the power supply's power cord from grounded outlet first to ensure the safety of CPU.

Overclocking

*This motherboard is designed to support overclocking. However, please make sure your components are able to tolerate such abnormal setting, while doing overclocking. Any attempt to operate beyond product specifications is not recommended. **We do not guarantee the damages or risks caused by inadequate operation or beyond product specifications.***

Memory

The mainboard provides 4 slots for 184-pin DDR SDRAM DIMM (Double In-Line Memory Module) modules and supports the memory size up to 4GB. You can install DDR400/DDR333/DDR266 modules on the DDR DIMM slots (DDR 1~4).

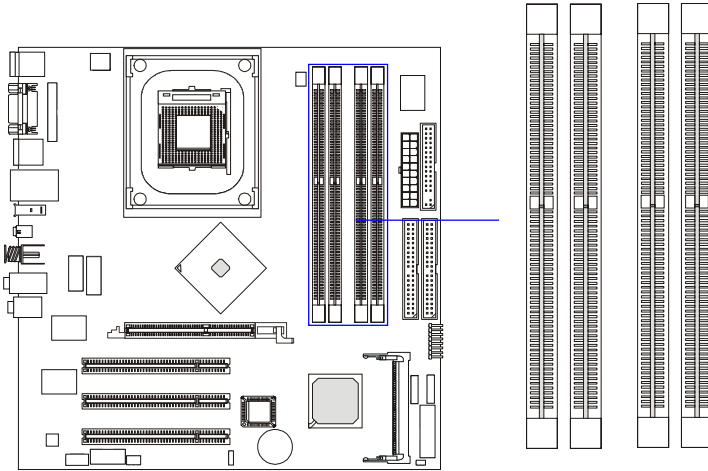

**DDR DIMM Slots
(DDR 1~4)**

Introduction to DDR SDRAM

DDR (Double Data Rate) SDRAM is similar to conventional SDRAM, but doubles the rate by transferring data twice per cycle. It uses 2.6 volts as opposed to 3.3 volts used in SDR SDRAM, and requires 184-pin DIMM modules rather than 168-pin DIMM modules used by SDR SDRAM. High memory bandwidth makes DDR an ideal solution for high performance PC, workstations and servers.

DDR Population Rules

Install at least one DIMM module on the slots. Each DIMM slot supports up to a maximum size of 1GB. Users can install either single- or double-sided modules to meet their own needs. Please note that **Channel A DIMMs (DIMM1 & DIMM2) can respectively work alone, but Channel B DIMMs (DIMM3 & DIMM4) must work in pair with Channel A DIMMs.** In order to have better performance, it is recommended to install memory modules of **the same type and density** on DDR DIMMs “in pairs” -- {DIMM1 & DIMM3} {DIMM2 & DIMM4}.

Please refer to the following table for detailed DDR population:

DIMM1 (Ch A)	DIMM2 (Ch A)	DIMM3 (Ch B)	DIMM4 (Ch B)	System Density
128MB~1GB				128MB~1GB
		128MB~1GB		128MB~1GB
128MB~1GB *	128MB~1GB *			256MB~2GB
		128MB~1GB #	128MB~1GB #	256MB~2GB
128MB~1GB		128MB~1GB		256MB~2GB
128MB~1GB *	128MB~1GB *	128MB~1GB #	128MB~1GB #	512MB~4GB

Installing DDR Modules

1. The DDR DIMM has only one notch on the center of module. The module will only fit in the right orientation.
2. Insert the DIMM memory module vertically into the DIMM slot. Then push it in until the golden finger on the memory module is deeply inserted in the socket.
3. The plastic clip at each side of the DIMM slot will automatically close.

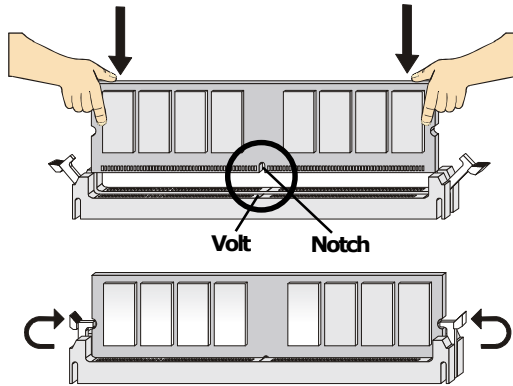

MSI Reminds You...

You can barely see the golden finger if the module is properly inserted in the socket.

Power Supply

The mainboard supports ATX power supply for the power system. Before inserting the power supply connector, always make sure that all components are installed properly to ensure that no damage will be caused.

ATX 20-Pin Power Connector: ATX1

This connector allows you to connect to an ATX power supply. To connect to the ATX power supply, make sure the plug of the power supply is inserted in the proper orientation and the pins are aligned. Then push down the power supply firmly into the connector.

ATX 12V Power Connector: JPW1

This 12V power connector is used to provide power to the CPU.

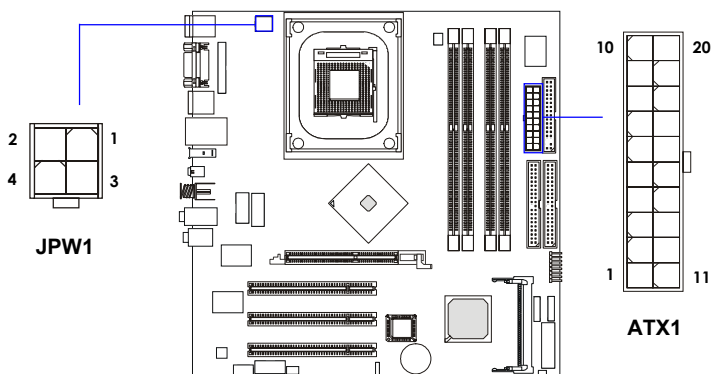

JPW1 Pin Definition

PIN	SIGNAL
1	GND
2	GND
3	12V
4	12V

ATX1 Pin Definition

PIN	SIGNAL	PIN	SIGNAL
1	3.3V	11	3.3V
2	3.3V	12	-12V
3	GND	13	GND
4	5V	14	PS_ON
5	GND	15	GND
6	5V	16	GND
7	GND	17	GND
8	PW_OK	18	-5V
9	5V_SB	19	5V
10	12V	20	5V

Back Panel

The back panel provides the following connectors:

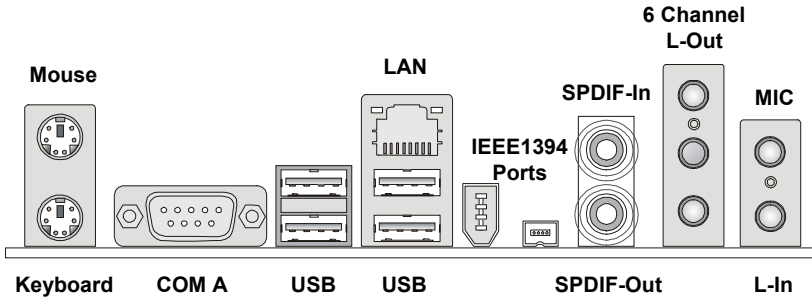

Mouse Connector

The mainboard provides a standard PS/2[®] mouse mini DIN connector for attaching a PS/2[®] mouse. You can plug a PS/2[®] mouse directly into this connector. The connector location and pin assignments are as follows:

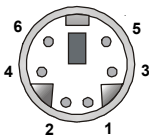

PS/2 Mouse (6-pin Female)

Pin Definition

PIN	SIGNAL	DESCRIPTION
1	Mouse DATA	Mouse DATA
2	NC	No connection
3	GND	Ground
4	VCC	+5V
5	Mouse Clock	Mouse clock
6	NC	No connection

Keyboard Connector

The mainboard provides a standard PS/2® keyboard mini DIN connector for attaching a PS/2® keyboard. You can plug a PS/2® keyboard directly into this connector.

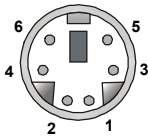

PS/2 Keyboard (6-pin Female)

Pin Definition

PIN	SIGNAL	DESCRIPTION
1	Keyboard DATA	Keyboard DATA
2	NC	No connection
3	GND	Ground
4	VCC	+5V
5	Keyboard Clock	Keyboard clock
6	NC	No connection

RJ-45 LAN Jack

The mainboard provides a RJ-45 connector that allows your computer to be connected to a network environment.

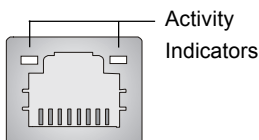

LAN Jack
(RJ-45)

Pin	Signal	Description
1	TDP	Transmit differential pair
2	TDN	Transmit differential pair
3	RDP	Receive differential pair
4	NC	Not used
5	NC	Not used
6	RDN	Receive differential pair
7	NC	Not used
8	NC	Not used

USB Connectors

The mainboard provides a UHCI (Universal Host Controller Interface) Universal Serial Bus root for attaching USB devices such as keyboard, mouse or other USB-compatible devices. You can plug the USB device directly into the connector.

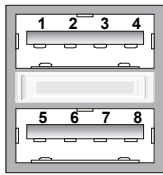

USB Ports

USB Port Description

PIN	SIGNAL	DESCRIPTION
1	VCC	+5V
2	-Data 0	Negative Data Channel 0
3	+Data0	Positive Data Channel 0
4	GND	Ground
5	VCC	+5V
6	-Data 1	Negative Data Channel 1
7	+Data 1	Positive Data Channel 1
8	GND	Ground

Serial Port Connector: COM A

The mainboard offers one 9-pin male DIN connectors as serial port COM A. This port is a 16550A high speed communication port that sends/receives 16 bytes FIFOs. You can attach a serial mouse or other serial devices directly to this connector.

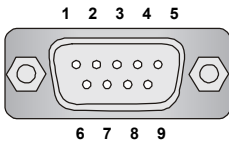

9-Pin Male DIN Connector

Pin Definition

PIN	SIGNAL	DESCRIPTION
1	DCD	Data Carry Detect
2	SIN	Serial In or Receive Data
3	SOUT	Serial Out or Transmit Data
4	DTR	Data Terminal Ready)
5	GND	Ground
6	DSR	Data Set Ready
7	RTS	Request To Send
8	CTS	Clear To Send
9	RI	Ring Indicate

SPDIF Connectors

The SPDIF connectors provided on the back panel can be used to connect your digital audio equipment.

SPDIF
IN



SPDIF
OUT

IEEE1394 Ports

The mainboard provides two IEEE 1394 ports. The mini IEEE1394 port is designed for you to connect the IEEE1394 device with external power. The standard IEEE1394 port connects to IEEE1394 devices without external power. The IEEE1394 high-speed serial bus complements USB by providing enhanced PC connectivity for a wide range of devices, including consumer electronics audio/video (A/V) appliances, storage peripherals, other PCs, and portable devices.



**IEEE1394 Port
(Standard)**



**IEEE1394 Port
(Mini)**

Audio Port Connectors

Line Out is a connector for Speakers or Headphones. **Line In** is used for external CD player, Tape player, or other audio devices. **Mic** is a connector for microphones.

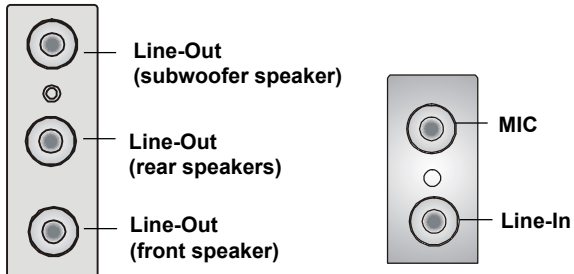

Connectors

The mainboard provides connectors to connect to FDD, IDE HDD, case, modem, LAN, USB Ports, IR module and CPU/System/Power Supply FAN.

Floppy Disk Drive Connector: FDD1

The mainboard provides a standard floppy disk drive connector that supports 360K, 720K, 1.2M, 1.44M and 2.88M floppy disk types.

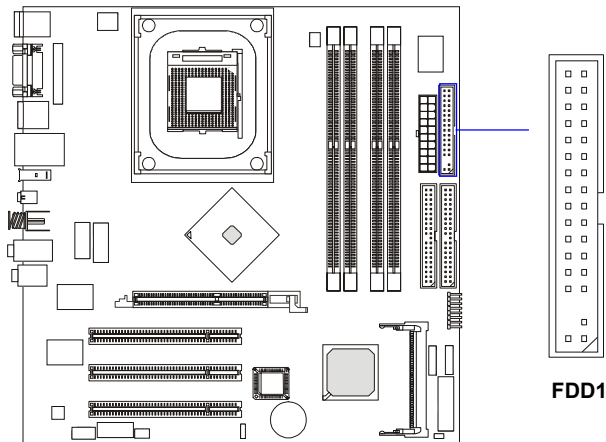

Hard Disk Connectors: IDE1 & IDE2

The mainboard has a 32-bit Enhanced PCI IDE and Ultra DMA 33/66/100 controller that provides PIO mode 0~4, Bus Master, and Ultra DMA33/66/100 function. You can connect up to four hard disk drives, CD-ROM, 120MB Floppy (reserved for future BIOS) and other devices. These connectors support the provided IDE hard disk cable.

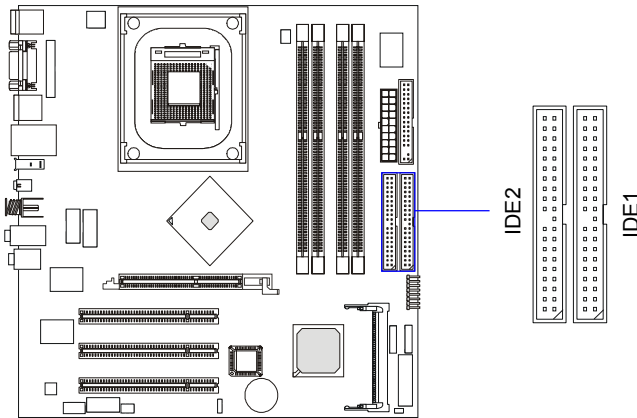

IDE1 (Primary IDE Connector)

The first hard drive should always be connected to IDE1. IDE1 can connect a Master and a Slave drive. You must configure second hard drive to Slave mode by setting the jumper accordingly.

IDE2 (Secondary IDE Connector)

IDE2 can also connect a Master and a Slave drive.



MSI Reminds You...

If you install two hard disks on cable, you must configure the second drive to Slave mode by setting its jumper. Refer to the hard disk documentation supplied by hard disk vendors for jumper setting instructions.

Fan Power Connectors: CFAN1

The CFAN1 (processor fan) supports system cooling fan with +12V. It supports three-pin head connector. When connecting the wire to the connectors, always take note that the red wire is the positive and should be connected to the +12V, the black wire is Ground and should be connected to GND. If the mainboard has a System Hardware Monitor chipset on-board, you must use a specially designed fan with speed sensor to take advantage of the CPU fan control.

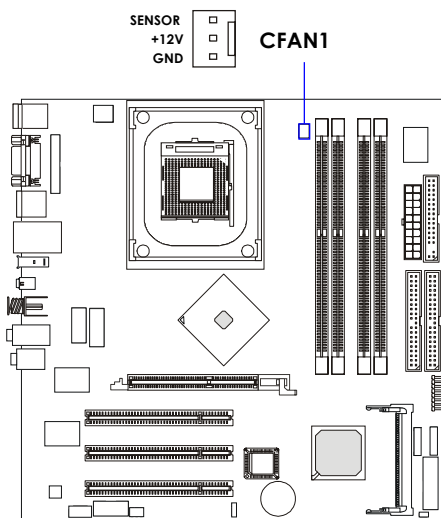

MSI Reminds You...

Always consult the vendors for proper CPU cooling fan.

Front Panel Audio Connector: JAUDIO1

The JAUDIO1 front panel audio connector allows you to connect front panel audio devices if available.

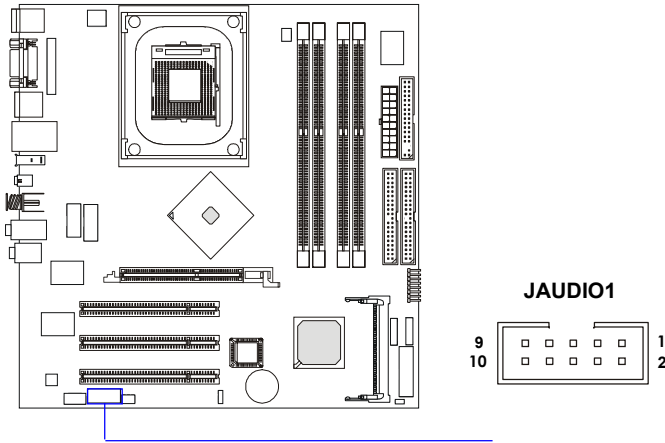

JAUDIO1 Pin Definition

Pin	Description	Pin	Description
1	Speaker_R	2	Front_R
3	Speaker_L	4	Front_L
5	GND	6	GND
7	MIC_IN	8	Line_Next_R
9	MIC_IN_S	10	Line_Next_L



MSI Reminds You...

If you don't want to connect to the front audio header, pins 1 & 2, 3 & 4 have to be jumpered in order to have signal output directed to the rear audio ports. Otherwise, the Line-Out connector on the back panel will not function.

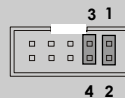

IEEE 1394 Connector: J7

The mainboard provides one IEEE1394 connector with housing that allows you to connect optional IEEE 1394 ports.

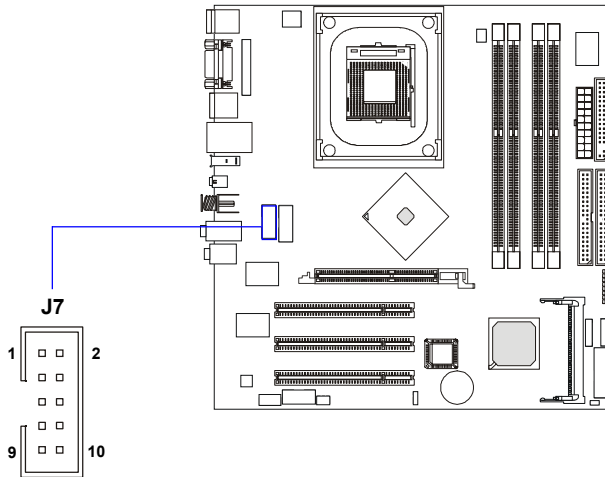

Pin Definition

PIN	SIGNAL	PIN	SIGNAL
1	IEGND	2	GND
3	TPA0-	4	TPA0+
5	Power	6	Power
7	TPB0+	8	TPB0-
9	GND	10	IEGND

Joystick/Game Connector: J8

You can connect a joystick or game pad to this connector.

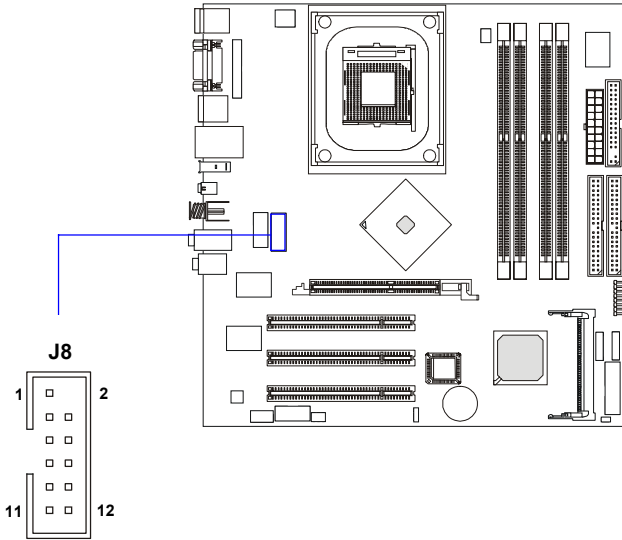

J9 Pin Definition

Pin	Description	Pin	Description
1	FVCC5 (power)	2	Key pin
3	RXD	4	GP4
5	GP5	6	GP6
7	GP7	8	GP2
9	GP1	10	GP0
11	GP3	12	TXD

Serial ATA Connectors: SATA1 / SATA2

The mainboard has dual high-speed Serial ATA interface connectors, SATA1 & SATA2. Each supports 1st generation serial ATA data rates of 150 MB/s. Both connectors are fully compliant with Serial ATA 1.0 specifications. Each Serial ATA connector can connect to 1 hard disk device. Please refer to *Serial ATA Raid* manual for detail software installation procedure.

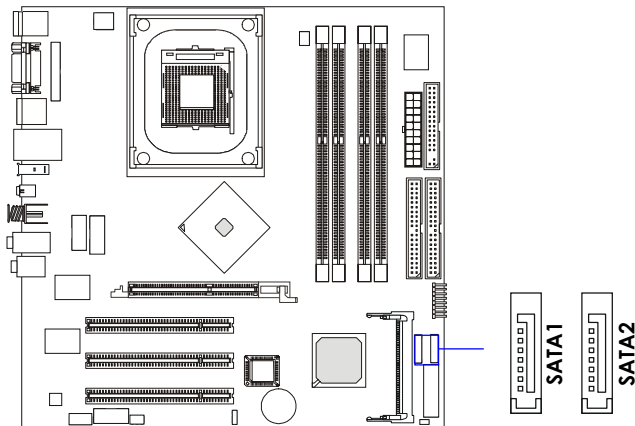

SATA1 & SATA2 Pin Definition

PIN	SIGNAL	PIN	SIGNAL
1	GND	2	TXP
3	TXN	4	GND
5	RXN	6	RXP
7	GND		

Optional Serial ATA cable

Take out the dust cover and connect to the hard disk devices

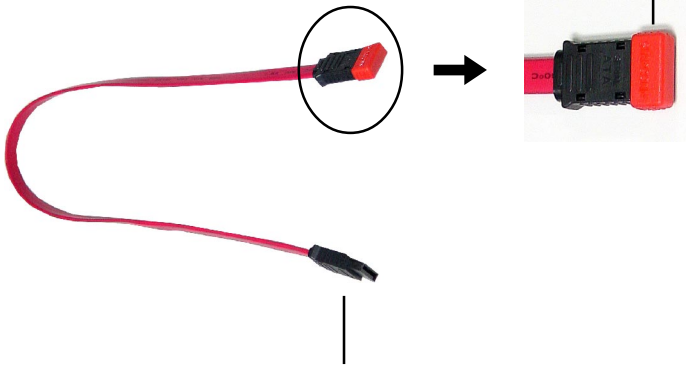

Connect to SATA1 or SATA2



MSI Reminds You...

Please do not fold the serial ATA cable in a 90-degree angle, which will cause the loss of data during the transmission.

Video-In Connector: JVIDEO1

The connector is for CD-ROM video connector.

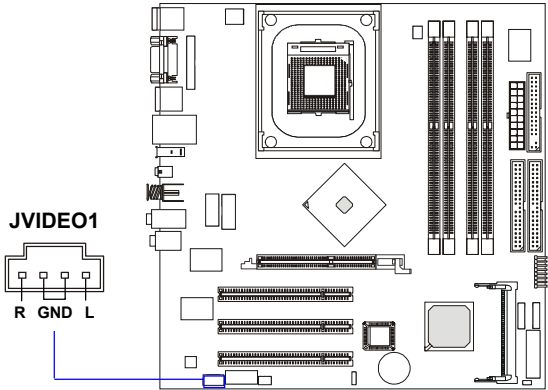

Front Panel Connector: F_P1

The mainboard provides one front panel connector for electrical connection to the front panel switches and LEDs.

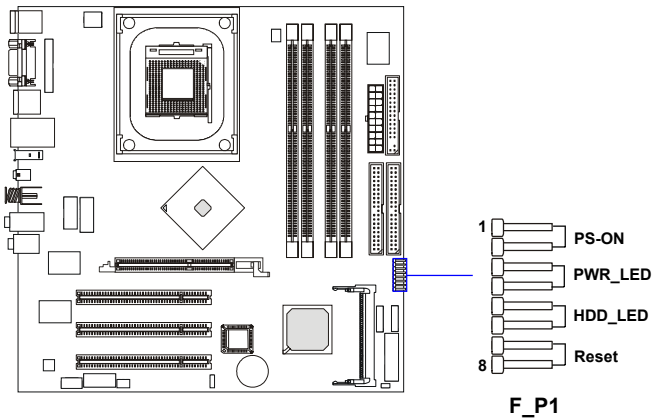

Front USB Connector: JUSB1

The mainboard provides one USB 2.0 pin header *JUSB1* (optional USB 2.0 bracket available) that is compliant with Intel® I/O Connectivity Design Guide. USB 2.0 technology increases data transfer rate up to a maximum throughput of 480Mbps, which is 40 times faster than USB 1.1, and is ideal for connecting high-speed USB interface peripherals such as **USB HDD**, **digital cameras**, **MP3 players**, **printers**, **modems** and the like.

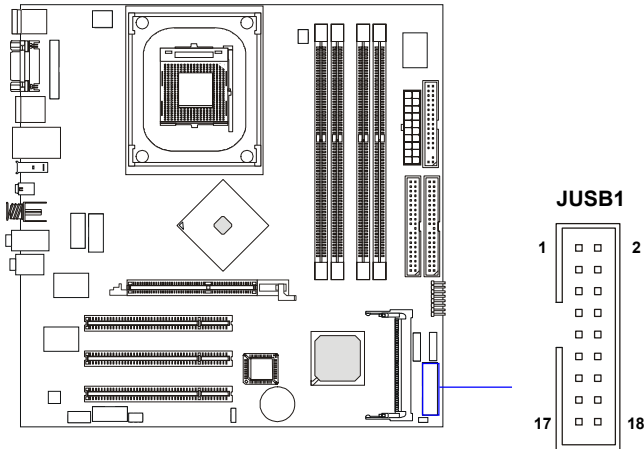

JUSB1 Pin Definition

Pin	Description	Pin	Description
1	Power	2	Power
3	D1+	4	D0+
5	D1-	6	D0-
7	GND	8	GND
9	SGND	10	SGND
11	GND	12	GND
13	D3-	14	D2-
15	D3+	16	D2+
17	Power	18	Power

SPDIF Connector: JSPDIF1

The connector is used to connect an optional bracket for SPDIF (Sony & Philips Digital Interconnect Format) digital audio transmission.

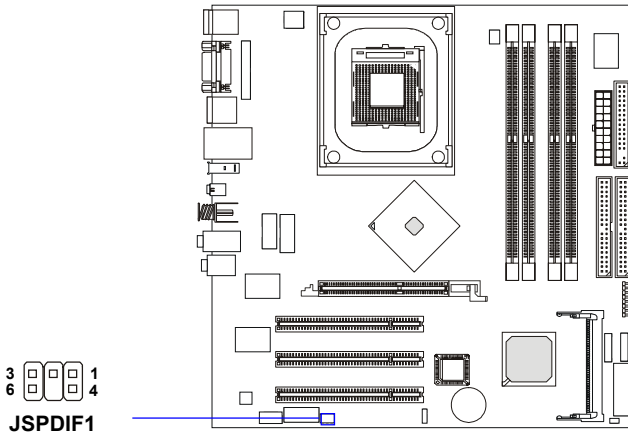

JSPDIF1 Pin Definition

Pin	Description	Pin	Description
1	VCC5	2	VCC3
3	SPDIF-O	4	NC
5	GND	6	SPDIF-I

Print Port: JLPT

This mainboard provides a pin header, JLPT, for connecting a printer.

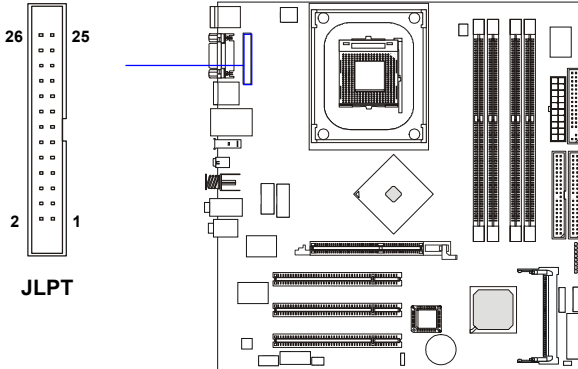

Pin Definition

PIN	DESCRIPTION
1	STROBE
2	DATA0
3	DATA1
4	DATA2
5	DATA3
6	DATA4
7	DATA5
8	DATA6
9	DATA7
10	ACK#
11	BUSY
12	PE
13	SELECT
14	AUTO FEED#
15	ERR#
16	INIT#
17	SLIN#
18	GND
19	GND
20	GND
21	GND
22	GND
23	GND
24	GND
25	GND
26	NC

Jumpers

The motherboard provides the following jumpers for you to set the computer's function. This section will explain how to change your motherboard's function through the use of jumpers.

Clear CMOS Jumper: JBAT1

There is a CMOS RAM on board that has a power supply from external battery to keep the data of system configuration. With the CMOS RAM, the system can automatically boot OS every time it is turned on. That battery has long life time for at least 5 years. If you want to clear the system configuration, use the JBAT1 (Clear CMOS Jumper) to clear data. Follow the instructions below to clear the data:

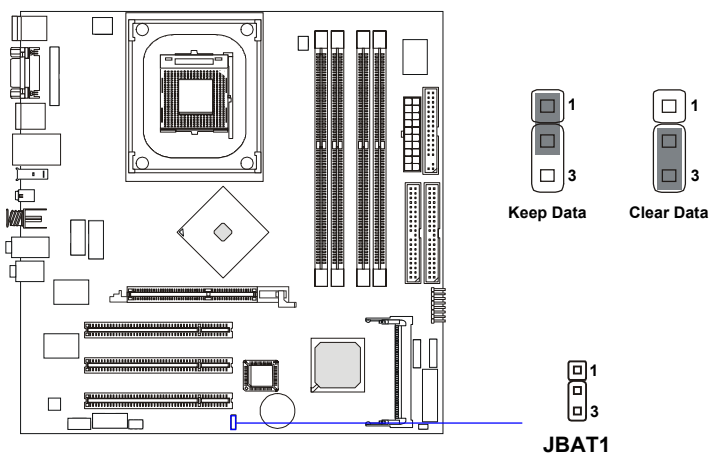

MSI Reminds You...

You can clear CMOS by shorting 2-3 pin while the system is off. Then return to 1-2 pin position. Avoid clearing the CMOS while the system is on; it will damage the mainboard.

BIOS Flash Jumper: JBIOS1

The jumper is used to lock or unlock the boot block area on BIOS. When unlocked, the BIOS boot block area can be updated. When locked, the BIOS boot block area cannot be updated.

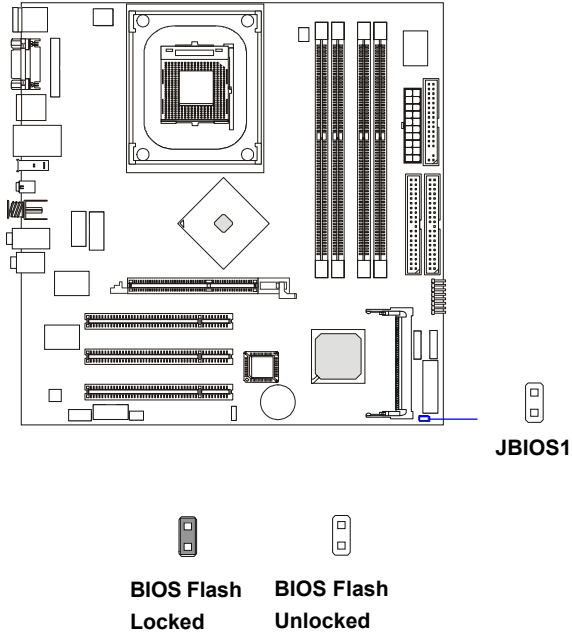

Slots

The motherboard provides one AGP slot and three 32-bit PCI bus slots.

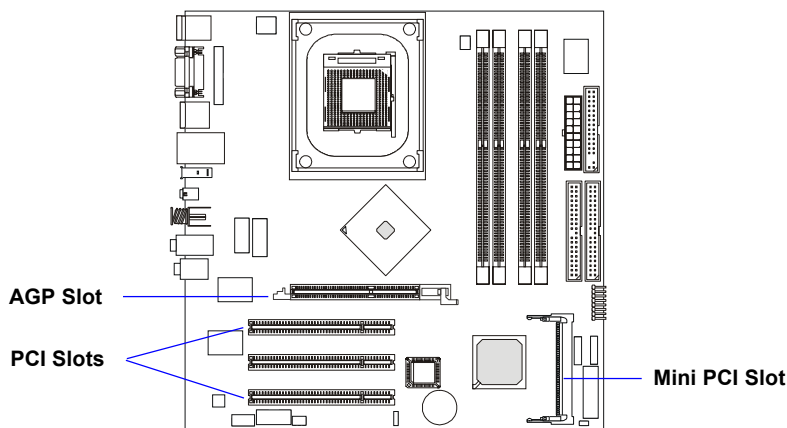

AGP (Accelerated Graphics Port) Slot

The AGP slot allows you to insert the AGP graphics card. AGP is an interface specification designed for the throughput demands of 3D graphics. It introduces a 66MHz, 32-bit channel for the graphics controller to directly access main memory. The onboard AGP slot supports up to 8X AGP card.

PCI (Peripheral Component Interconnect) Slots

The PCI slots allow you to insert the expansion cards to meet your needs. When adding or removing expansion cards, make sure that you unplug the power supply first. Meanwhile, read the documentation for the expansion card to make any necessary hardware or software settings for the expansion card, such as jumpers, switches or BIOS configuration. ***The second PCI slot (in BLUE color) supports 2 master devices.***

Mini PCI Slot

This slot is used to connect the optional MS-9518 SCSI card, MS-9513 VGA card, or MS-9514 IEEE 1394 card.

PCI Interrupt Request Routing

The IRQ, acronym of interrupt request line and pronounced I-R-Q, are hardware lines over which devices can send interrupt signals to the microprocessor. The PCI IRQ pins are typically connected to the PCI bus INT A# ~ INT D# pins as follows:

	Order 1	Order 2	Order 3	Order 4
PCI Slot 1	INT B#	INT C#	INT D#	INT A#
PCI Slot 2	INT C#	INT D#	INT A#	INT B#
PCI Slot 3	INT D#	INT A#	INT B#	INT C#